

PE-FN10ACA 10W

PE-FN20ACA 20W

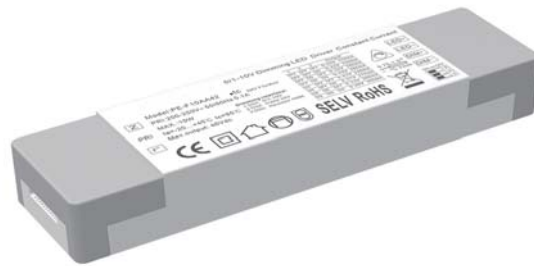

RoHS SELV CE Class 2



Features:

1. integrate multiple dimming and color matching interfaces
2. 0/1-10v brightness adjustment, color matching temperature
3. digital control output without stroboscopic
4. AC input 200-250v range
5. natural air cooling, moisture-proof, heat conducting silicone heat dissipation process
6. deep dimming design
7. multiple protection functions
8. crimping design, convenient and fast

Application:

1. Led dual color light source
2. villa intelligent lighting
3. wireless intelligent lighting system can be accessed
4. museum lighting
5. high end commercial lighting

General description:

1. two channel signal control is adopted, one channel is 0/1-10v to control the brightness, the other channel is 0/1-10v to control the color temperature, the CPU controls the dimming curve, and the mixed frequency control, To achieve visual perception of brightness, the raw materials used are first-line brands, imported chip ultra deep dimming design, matching a variety of intelligent dimming systems on the market Precise control of color temperature, ultra small size design (if the system is a mixed color temperature mode with two channels of brightness adjustment at the same time, it needs to customize the program)

Specification:

Model		PE-FN10ACA42	PE-FN20ACA42
OUTPUT	Output Voltage	9-42Vdc 9-41Vdc 9-37Vdc 9-33Vdc 9-28Vdc	9-42Vdc
	Max Output Voltage	42Vdc	42Vdc
	Non-load Output Voltage	45Vdc	45Vdc
	Output Current	120/180/200/240/270/300/350mA	200/250/280/300/350/400/450/500mA
	Output Power	1.5W-9.8W	2W-21W
	Strobe Level	No Flicker	
	Dimming Range	0~100%, LEDstart at 0.03%possible.	
	PWM Dimming Frequency	>3600Hz	
	Current Accuracy	±5%	
	Power down mode	No signal maximum brightness output	
INPUT	Dimming Interface	0-10V 1-10V signal interface current <2ma	
	Input Voltage Range	200-250Vac	
	Frequency	50/60Hz	
	Input Current	<0.045A ac230v	<0.055A ac230v
	Power Factor	PF>0.94/230V ac(at full load)	PF>0.95/230V ac(at full load)
	THD	230Vac@THD <14% (at full load)	
	Efficiency(typ.)	81%	86%
	Inrush Current(typ.)	cold start25A@230Vac	
	Anti Surge	L-N: 1.8kV	
	Leakage Current	<0.25mA/230Vac	
ENVIRONMENT	Working Temperature	ta: 45°C tc: 80 °C	
	Working Humidity	20 ~ 95%RH, non-condensing	
	Storage Temp., Humidity	-40 ~ 80°C, 10~95%RH	
	Temp.Coefficient	±0.03%/°C(0-50)°C	
	Vibration	10~500Hz, 2G 12min./1cycle, period for 72min. each along X, Y, Z axes.	
PROTECTION	Over-heat Protection	Intelligently adjusting or turning off the output current if the PCB temperature ≥110°C, , auto recovers.	
	Over Load Protection	Shut down the output when rated power≥102%, auto recovers.	
	Short Circuit Protection	Shut down automatically if short circuit occurs, auto recovers.	
	Non-load Protection	output Constant Voltage.	
SAFETY & EMC	Withstand Voltage	I/P-O/P: 3750Vac	
	Isolation Resistance	I/P-O/P: 100MΩ/500VDC/25°C/70%RH	
	Safety Standards	IEC/EN61347-1, IEC/EN61347-2-13	
	EMC Emission	/	
	EMC Immunity	/	
OTHERS	Strobe Test Standard	IEEE 1789	
	Dimension	130×37×22.6mm(L×W×H)	
	Packing	PE bag	
	Weight(G.W.)	85g±10g	

Dimensions :

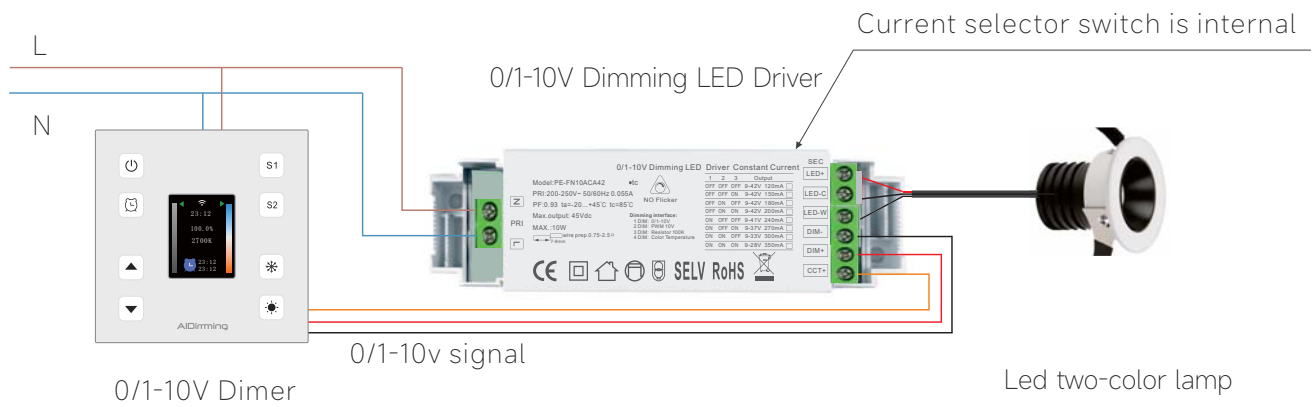

Wiring:

1. Input terminal wiring: suitable for wire gauge 22awg-14awg (0.5mm² – 1.5mm²), stripping requires 9-10mm tin
2. Output terminal wiring: suitable for wire gauge 22awg-12awg (0.5mm² – 1.5mm²), stripping requires 6-7mm tin
3. Output terminal wiring: the positive pole of the output LED is the common terminal, and the three wire led can be connected to one of the positive poles.

Working Curve:

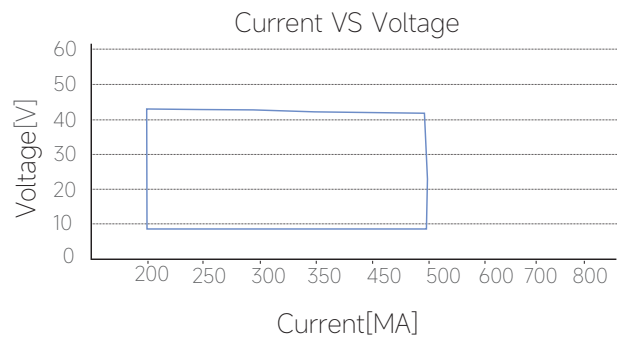
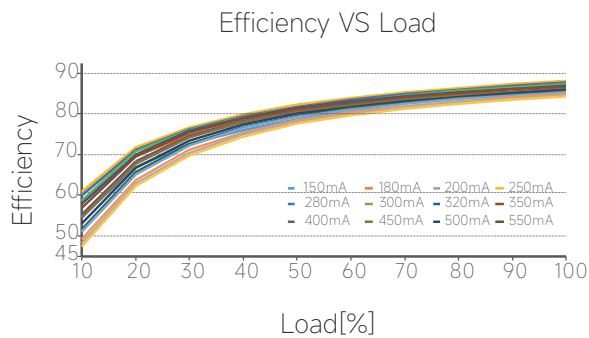
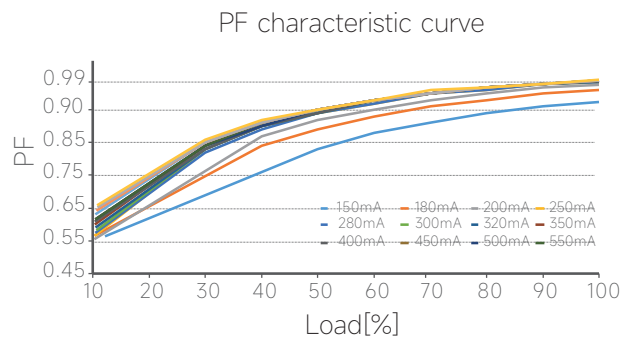
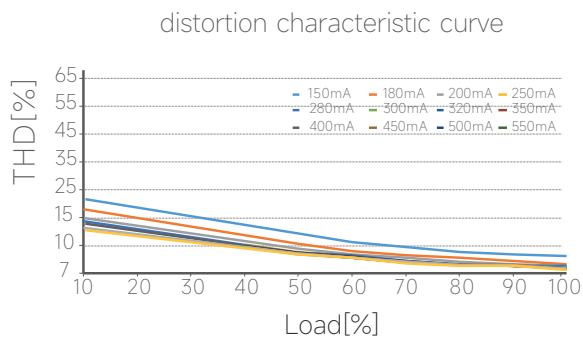

Dimensions :

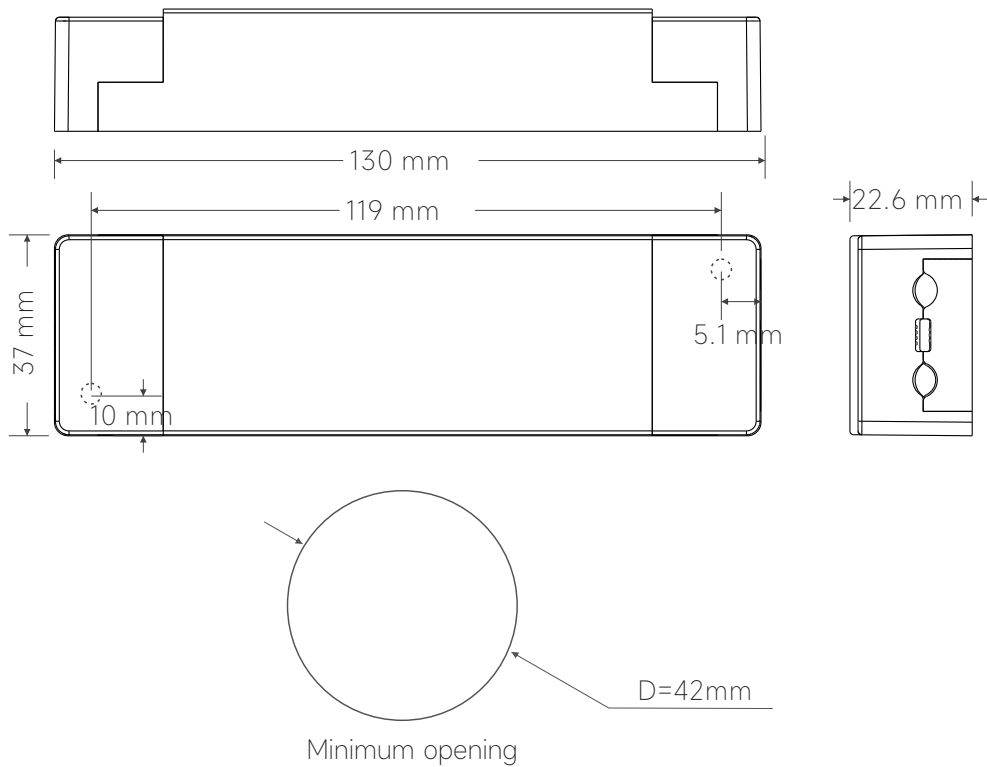

Product Label:

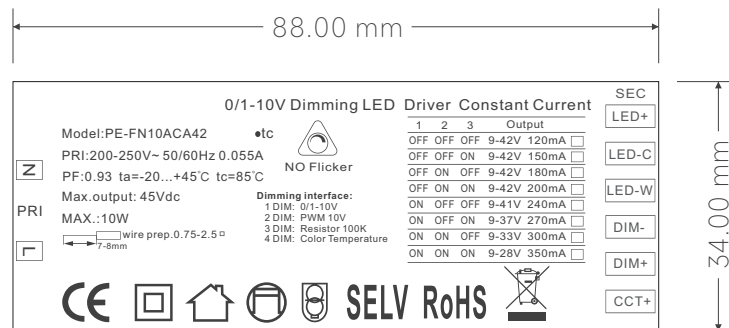

LED Current Selection:

DIP switch for 4 optional currents' quick selection(see the table below).

Product model	DIP Switch									
PE-FN10ACA42	Output Current	120mA	150mA	180mA	200mA	240mA	270mA	300mA	350mA	
	Output Voltage	9-42V	9-42V	9-42V	9-42V	9-41V	9-37V	9-33V	9-28V	
	Output Power	1.5W-5W	1.5W-6.3W	1.6W-7.5W	1.8W-8.4W	2.1W-9.8W	2.4W-10W	2.7W-10W	3.1W-10W	
PE-FN20ACA42	Output Current	150mA	200mA	250mA	300mA	350mA	400mA	450mA	500mA	
	Output Voltage	9-42V	9-42V	9-42V	9-42V	9-42V	9-42V	9-42V	9-42V	
	Output Power	1.5W-6.3W	1.8W-8.4W	2.2W-10.5W	2.7W-12.6W	3.1W-14.7W	3.6W-16.8W	4W-18.9W	4.5W-21W	

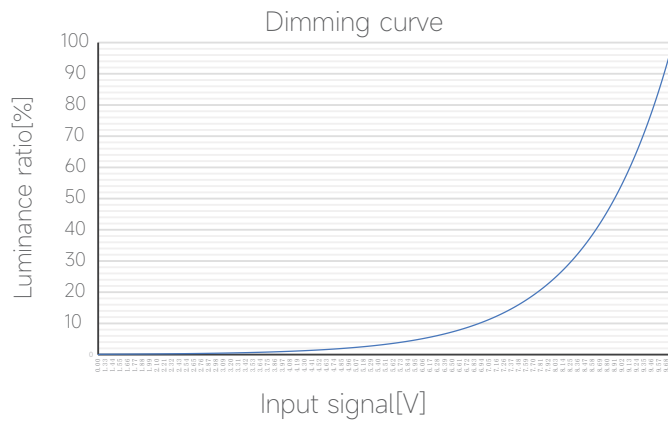

The use of guidance:

Unless otherwise specified, all specifications and parameters are measured at 230VAC input, rated load and 25 °C Ambient Temperature

This product has a press line cap at the input, with self-locking clamping, it can be opened up with a screwdriver, then you will see the input terminal connected with the AC line L and the null line N, The output terminal connect a according to the product label, notice the positive and negative pole.

**1:please pay attention to the distinction between input and out put , connect correctly, then power on

**2:please connect first the load of the DC output, open the driver after checking; in the constant current mode, if power on at open circuit, please turn off the driver and can't connect the LED until the electric energy stored by the output release, or it may damage the LED ;

**3.this type of driver is only limited to the use of the LED lamps ,the input voltage range is AC200-250V,the heat insulation cotton and other items that obstruct the heat dissipation of the product, which conforms to the product under the specified output voltage, current range, the use environment temperature is -20-45 degrees, and the surface can not cover the conditions of the environment, this product enjoys 5 years of free warranty.

1.the LED lamp doesn't bright after the dimming driver is connected at the first time, please turn off the AC input and check as follow:

- 1)whether or not DC output bad contact;
- 2)whether DC output polarity is reversed, or the LED board is welded anti;
- 3)whether AC input is bad contact, test after eliminating these failures;

2.the device has good connection, LED lights, but the LED flicker, please turn off the AC input and check as follow:

- 1).whether or not the parameters and actual parameters match.
- 2).please timely communicate with us if you have any questions in the using, we will try our best to solve the problems with you.

Difference between 0-10V and 1-10V:

- 1.When the 0 / 10V dimmer is adjusted to the maximum 10V, the output current will reach 100% of the power output, and the brightness will reach 100%. When the 0-10V dimmer is adjusted to 0V,the current will be the minimum, and the light will be turned off; When the 1-10V dimming is adjusted to 1V, the current is the minimum and the light is off.
- 2.Difference between 0-10V and 1-10V dimming: different starting and closing voltage, 0-10V is on at 0.7V, (the min brightness) 1-10V is on at 1.2V (the min brightness).
- 3.Digital dimming driver 0-10V and 1-10V dimming automatic identification two dimming modes.
- 4.The same signal circuit controls light and dark at the same time.
- 5.Dimmer (dimming system) is divided into 0-10V and 1-10V dimming signals.
- 6.Dimming compatibility is related to the control distance of signal line and the number of control power supply. If the number is too large or the signal line is too long, problems such as can not adjusted lower and can not adjusted off will occur.

Statement:

The pictures and specifications are for reference, subject to the real object.
If there is any change in the specifications, it will be notified separately.